





Wireless Technology by ThermAlign Pty Ltd



Application	Code	Package	Hardware				Software		
			Customised Case	2 Ch DAQ	Accelerometer with Mag Base	Balance Kit (Tacho)	VibePro	IVibra Meter	IRotor Balancer
Vibration	VA	Analyser & Trending	✓	✓	✓		✓		
	VAMC	Analyser & Machine Certification	✓	✓	✓		✓	✓	
Balancing	RB	1 & 2 Plane Balancer	✓	✓	✓	✓			✓
	VARB	1 & 2 Plane Balancer with Vibration Analysis	✓	✓	✓	✓	✓		✓
Premium	VBC	Complete System	✓	✓	✓	✓	✓	✓	✓
All packages to be nominated with choice of IPad Air or IPad mini . Standard size is 16GB without Cellular. All IPad types available upon request.									

Contact ThermAlign for further information and current prices.

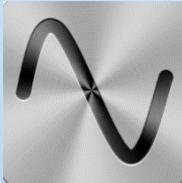
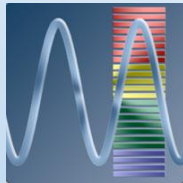
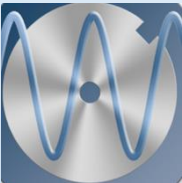
P: 0419 600 143 E: admin@thermalign.com.au

Wireless Technology by ThermAlign Pty Ltd



Shaft Align

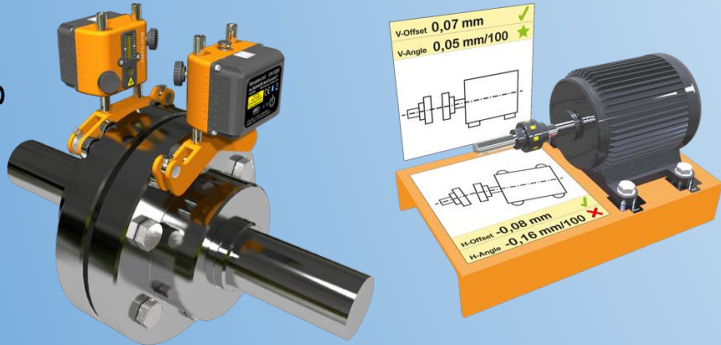

State of the art, made for iPad, wireless technology. Shaft Alignment and Soft Foot programmes. Custom, professional, instant reporting. The most intuitive alignment equipment ever produced. Affordable, accurate shaft alignment, every plant needs one.

Level



Finally, geometric alignment at an affordable price point. Made for iPad wireless technology with multiple applications including; Straightness, Squareness, Flatness, Shaft Level & More

Contact ThermAlign for further information and current prices.

P: 0419 600 143 E: admin@thermalign.com.au